

## Mechanical and Aerospace Engineering

**Undergraduate Handbook**

PRINCETON UNIVERSITY  
School of Engineering and Applied Science  
**DEPARTMENT OF  
MECHANICAL AND AEROSPACE ENGINEERING**  
**UNDERGRADUATE PROGRAMS**  
HANDBOOK

*Effective Academic Year 2020-2021*

**Spring 2020 Edition**  
(includes Class of 2020)

*This booklet supersedes all others and applies to the Classes of 2021 through 2024 and beyond.*

This booklet describes the undergraduate academic program of the MAE Department in more detail than that available in the Undergraduate Announcement. It provides information both to prospective concentrators and to undergraduates already enrolled in the Department. For specific course descriptions see the Undergraduate Announcement or the Graduate School Announcement as appropriate.

Mechanical and Aerospace Engineering Department Web Site:

<https://mae.princeton.edu/>

Chairman	Howard A. Stone	258-9493 D-326	<a href="mailto:hastone@princeton.edu">hastone@princeton.edu</a>
Director of Undergraduate Studies	Michael G. Littman	258-5198 D-202A	<a href="mailto:mlittman@princeton.edu">mlittman@princeton.edu</a>
Undergraduate Administrator	Jo Ann Love	258-5169 D-230	<a href="mailto:jolove@princeton.edu">jolove@princeton.edu</a>
Undergraduate Program Assistant	Theresa Russo	258-7972 Atrium 31	<a href="mailto:tar3@princeton.edu">tar3@princeton.edu</a>
Director of Graduate Studies <i>Effective July 1, 2020</i>	Michael Mueller	258-5191 D-332	<a href="mailto:muellerm@princeton.edu">muellerm@princeton.edu</a>
Graduate Administrator	Jill Ray	258-4683 D-228	<a href="mailto:jfray@princeton.edu">jfray@princeton.edu</a>
Department Manager	Jennifer Widdis	258-5168 D-214	<a href="mailto:jwiddis@princeton.edu">jwiddis@princeton.edu</a>
Business Manager	Mala Vora	258-5139 D-210	<a href="mailto:mvora@princeton.edu">mvora@princeton.edu</a>

# TABLE OF CONTENTS

<b>I. OVERVIEW.....</b>	<b>1</b>
<b>II. REQUIREMENTS .....</b>	<b>4</b>
<b>A. INTRODUCTORY COURSES .....</b>	<b>4</b>
<b>B. UPPERCLASS COURSES .....</b>	<b>5</b>
<b>C. DEPARTMENTAL COURSES.....</b>	<b>6</b>
<b>D. GENERAL INFORMATION .....</b>	<b>8</b>
<b>III. RECOMMENDED SAMPLE CURRICULA.....</b>	<b>10</b>
<b>A. COURSE DESCRIPTIONS.....</b>	<b>10</b>
<b>B. STANDARD SOPHOMORE CURRICULUM.....</b>	<b>14</b>
<b>C. MECHANICAL ENGINEERING .....</b>	<b>15</b>
<b>D. AEROSPACE ENGINEERING .....</b>	<b>18</b>
<b>E. ENGINEERING PHYSICS PROGRAM .....</b>	<b>19</b>
<b>F. MATERIALS SCIENCE AND ENGINEERING PROGRAM.....</b>	<b>21</b>
<b>G. INTERDEPARTMENTAL PROGRAMS .....</b>	<b>23</b>
<b>IV. DEPARTMENTAL PRIZES .....</b>	<b>25</b>
<b>V. INDEPENDENT WORK AND PUBLISHED PAPERS .....</b>	<b>26</b>
<b>VI. POST-GRADUATION PLANS .....</b>	<b>35</b>
<b>VII. FACULTY RESEARCH INTERESTS.....</b>	<b>36</b>
<b>VIII. WHO TO SEE FOR MORE INFORMATION.....</b>	<b>41</b>
UPPERCLASS ADVISORS .....	41
STUDENT DEPARTMENTAL COMMITTEE AND OTHER STUDENT COMMITTEES .....	43
INTERDEPARTMENTAL PROGRAMS .....	44
STUDY ABROAD AND FOREIGN EXCHANGE .....	45
<b>APPENDIX I: REQUIREMENT SHEETS.....</b>	<b>47</b>
<b>AEROSPACE ENGINEERING.....</b>	<b>48</b>
<b>MECHANICAL ENGINEERING.....</b>	<b>50</b>
<b>AEROSPACE AND MECHANICAL ENGINEERING .....</b>	<b>52</b>

# THE DEPARTMENT OF MECHANICAL AND AEROSPACE ENGINEERING

## I. OVERVIEW

The Department of Mechanical and Aerospace Engineering is concerned with the engineering science and technologies associated with ground, air, water, and space transportation, including control and dynamics of vehicles and systems, energy conversion and use, environmental effects, fluids, materials, and applied physics. To accommodate this breadth of interest, the Department offers two programs of study: **Mechanical Engineering** and **Aerospace Engineering**. Either program may be completed individually or, through careful planning and selection of technical electives, the requirements of both the **Mechanical and Aerospace Engineering programs** may be satisfied simultaneously. (See the Director of Undergraduate Studies for further information). Departmental students may also participate in the **SEAS Engineering Physics Program**, or other SEAS certificate programs such as **Engineering and Management Systems, Engineering Biology, Applied and Computational Mathematics, Robotics and Intelligent Systems, Materials Science in Engineering, Sustainable Energy, and the Program in Applications of Computing**.

Both the Mechanical and Aerospace Engineering programs draw on courses in the underlying fundamental sciences and mathematics during the first year and introductory engineering science courses during the second year. Students are shown the creative application of knowledge for the solution of technical problems. Various aspects of engineering design, the process of devising a system to meet a need, are introduced to the student through the laboratories in the second year and continue through the upper class years. Normally, during the third year all students take a two semester design sequence and additional engineering science courses, performing analyses and studying applications in the areas of energy, power systems, structures, and the dynamics of machines and their control. The courses in design offered during the third year, combined with further depth in engineering science, enable students to undertake realistic design projects during their senior year. The programs are designed to prepare the graduate for an engineering career and the ability to grow professionally.

The Department recognizes that students have a wide variety of career objectives. Some may intend to enter industry directly in an engineering capacity, or to continue studies in the graduate school in engineering or applied science. Others may wish to take an engineering program in preparation for careers in business, law, or medicine. Sufficient flexibility is provided within the undergraduate program in the Department to permit meeting these and other varied objectives while acquiring a foundation in the engineering disciplines and associated problem solving skills.

Independent work is an important complement to formal course work, and affords students the opportunity to collaborate closely with faculty and graduate students while working on real engineering problems. Support for student projects is available through the **John Marshall II Memorial Prize**, awarded annually to one or more seniors to support their experimental projects, with preference given to projects in aeronautics. Additionally, the **Morgan W. McKinzie '93 Senior Thesis Fund** provides financial support for independent work or senior thesis with preference given to projects in aircraft design and propulsion. The selection is based on proposals submitted by students in the fall of the senior year for both awards. Excellence in independent work is recognized by the Department through the **Donald Janssen Dike Award for Excellence in Undergraduate Research**, and outstanding senior thesis is recognized through the **Morgan W. McKinzie '93 Senior Thesis Prize**, both prizes are awarded on Class Day.

Departmental requirements are described in Section II. Sample curricula are presented in Section III. Titles of recent independent projects undertaken by undergraduates in the Department appear in Section V. Plans after graduation for the last five classes are summarized in Section VI and a brief description of the faculty research interests is found in Section VII. Section VIII lists "Who to See" among the faculty and students to obtain additional information.

The undergraduate programs in Aerospace and Mechanical Engineering are accredited by the Engineering Accreditation Commission of ABET, <http://www.abet.org>.

### **Program(s) Educational Objectives**

#### **Aerospace Engineering:**

##### **Objective No. 1**

Our graduates will think critically and creatively and excel in applying the fundamentals of aerospace engineering.

##### **Objective No. 2**

Our graduates will pursue a life of curiosity with a desire for learning and have the ability and self-confidence to adapt to rapid and major changes.

##### **Objective No. 3**

Our graduates will advance toward leadership in shaping the social, intellectual, business and technical worlds and by excelling in diverse careers.

## **Mechanical Engineering:**

### **Objective No. 1**

Our graduates will think critically and creatively and excel in applying the fundamentals of mechanical engineering.

### **Objective No. 2**

Our graduates will pursue a life of curiosity with a desire for learning, and have the ability and self-confidence to adapt to rapid and major changes.

### **Objective No. 3**

Our graduates will advance toward leadership in shaping the social, intellectual, business and technical worlds and by excelling in diverse careers.

## II. REQUIREMENTS (See Individual Forms, Appendix I.)

Some of the requirements may be satisfied by equivalent courses. *No courses taken to satisfy Mechanical or Aerospace program requirements may be taken on a pass/fail or audit basis with the exception of courses taken in spring semester 2020.* Students entering the Department are expected to meet the requirements for the 1<sup>st</sup> year established by the School of Engineering and Applied Science.

### A. Introductory Courses (Sophomore Year)

The required introductory courses that are prerequisites for the Departmental upper class courses, **normally completed by the end of the sophomore year**, are:

1. Mechanical and Aerospace Engineering
  - MAE 206 Introduction to Engineering Dynamics
  - MAE 221 Thermodynamics
  - MAE 222 Mechanics of Fluids
  - MAE 223 Modern Solid Mechanics<sup>1</sup>
  - MAE 224 Integrated Laboratory

The Sophomore Laboratory provides experiments associated with Thermodynamics (MAE 221), Mechanics of Fluids (MAE 222) and Electronics. (Some of these courses may be satisfied by Advanced Placement Credit).

2. Mathematics
  - MAT 201/202 Multivariable Calculus and Linear Algebra
  - or-**
  - MAT 203/204 Advanced Multivariable Calculus and Linear Algebra
3. Computer Programming (School of Engineering & Applied Science requirement)

All BSE students must take COS 126 to satisfy the BSE computing requirement.

---

<sup>1</sup> CEE205 is an acceptable substitute for MAE 223 for those students interested in structures



## **B. Upperclass Courses (Junior and Senior Year).**

To graduate, **all** Departmental students must satisfactorily complete the following requirements:

### **1. Applications of Mathematics**

**The following course** is required for both Mechanical and Aerospace Engineers.

MAE 305 (MAT 301) Mathematics in Engineering I

In addition, all Mechanical Engineers must take a mathematics elective usually selected from the following list:

- MAE 306 (MAT 392) Mathematics in Engineering II (strongly recommended for those planning graduate work in engineering or applied science)
- ORF 245 Fundamentals of Engineering Statistics
- ORF 307 Optimization
- ORF 309 Probability and Stochastic Systems (MAT 380/ELE 380)
- ORF 363 Computing and Optimization for the Physical and Social Sciences (COS 323)
- COS 302 Mathematics for Numerical Computing and Machine Learning
- COS 340 Reasoning About Computation
- MAT 330 Complex Analysis with Applications
- MAT 393 Mathematical Programming
- PHY 403 Mathematical Methods of Physics

(Alternatives not on this list must be approved by the Departmental Representative in advance).



## C. Departmental Courses

A minimum of eight upper level Departmental courses are required for the Mechanical Program and a minimum of nine upper level Departmental courses are required for the Aerospace Program, These courses must be distributed in the following manner:

1. **Engineering Science Courses** – In the Aerospace Program six courses are required and in the Mechanical Program five courses are required from Sections (a) (b) and (c). Core requirements for both programs are footnoted.

(a) **Dynamics and Control**

MAE 331 Aircraft Flight Dynamics<sup>1</sup>  
MAE 341 Space Flight<sup>1</sup>  
MAE 345 Introduction to Robotics  
MAE 433 Automatic Control Systems<sup>2</sup>  
MAE 434 Modern Control

(b) **Fluid Mechanics/Thermal Sciences**

MAE 328 Energy for a Greenhouse-Constrained World  
MAE 335 Fluid Dynamics<sup>3</sup>  
MAE 336 Viscous Flows<sup>3</sup> or MAE 552 Viscous Flows and  
Boundary Layers  
MAE 423 Heat Transfer<sup>3</sup>  
MAE 426 Rocket and Air-Breathing Propulsion Technology<sup>4</sup>  
MAE 427 Energy Conversion and the Environment: Transportation Applications<sup>4</sup>  
CBE 341 Mass, Momentum, and Energy Transport<sup>5</sup>

(c) **Materials/Structures**

MAE 323 Aerospace Structures<sup>7</sup>  
MAE 324 Structure and Properties of Materials<sup>6</sup>  
MSE 301 Materials Science and Engineering<sup>6</sup>  
CEE 312 Statics of Structures<sup>7</sup>  
CEE 361/MAE 325 Structural Analysis and Intro to Finite Element Methods<sup>7</sup>  
CEE 362 Structural Dynamics and Earthquake Engineering<sup>8</sup>  
CEE 364 Materials in Civil Engineering<sup>8</sup>

---

<sup>1</sup> MAE 331 or 341 required for Aerospace Engineers.

<sup>2</sup> MAE 433 required for Mechanical and Aerospace Engineers.

<sup>3</sup> MAE 335 or 336 or 423 required for Mechanical Engineers. MAE 335 only required for Aerospace Engineers.

<sup>4</sup> MAE 427 or 426 required for Aerospace Engineers (may be used as additional engineering science elective (technical elective) in the Mechanical Program.

<sup>5</sup> CBE 341 is an acceptable substitute for MAE 423 for Mechanical Engineers.

<sup>6</sup> MAE 324 or MSE 301 required for Mechanical and Aerospace Engineers.

<sup>7</sup> MAE 323 or CEE 312 or CEE 361 required for Mechanical and Aerospace Engineers.

<sup>8</sup> CEE 362 or CEE 364 may be considered as substitutes for the materials requirement. Requires the approval of the Director of Undergraduate Studies.

2. **Engineering Design Courses** – There are three design requirements in each program. Two are satisfied by completing courses appropriate to the program (core course requirements for each program are footnoted below). The third is satisfied by completing Senior Independent Work, Senior Thesis, or Senior Project (see Section C.3). If you are completing both the Mechanical and Aerospace Programs your design requirements would be MAE 321 Engineering Design, a Mechanical Design course (MAE 412 or MAE 322 or CEE 477) and an Aerospace Design course (MAE 332 or MAE 342). You will still need to complete Senior Independent Work, Senior Thesis, or Senior Project.

MAE 321 Engineering Design<sup>1</sup>  
MAE 322 Mechanical Design<sup>2</sup>  
MAE 332 Aircraft Design<sup>3</sup>  
MAE 342 Space System Design<sup>3</sup>  
MAE 412 Microprocessors for Measurement and Control<sup>2</sup>  
CEE 477 Engineering Design for Sustainable Development<sup>4</sup>

3. **Senior Independent work** - is the culminating experience for the mechanical and aerospace engineering programs. All seniors are required to participate in a research or engineering project. All projects must include elements of engineering design (*engineering design is the process of devising a system, component, or process to meet desired needs*). The following courses satisfy this requirement: MAE 439 Senior Independent Work (one semester, fall); MAE 440 Senior Independent Work (one semester, spring); MAE 442 Senior Thesis (year-long); MAE 444 Senior Project (year-long). **Students are strongly encouraged to select the year-long project or thesis option.** Senior projects are intended for teams or groups while senior thesis is intended for individuals. For senior project or thesis, work begins in the fall but enrollment is only in spring term when a double grade is awarded. *Please note: If a student has selected to participate in a year-long project or thesis and is enrolled in only three courses during the fall semester, it is required that they will enroll in Senior Project or Thesis during the spring semester. For these students, it will NOT be possible to drop-down to a one-semester course of Independent Work without incurring a failure for Independent Work in the fall term. In Spring term you must enroll in three taught courses plus senior thesis or senior project (senior thesis and senior project count as two courses). Therefore your senior year course load will be 3 in fall and 5 in spring as opposed to 4 in fall and 4 in spring. There are NO exceptions to this rule even if your total number of courses will exceed 36.*

MAE 439/440 (Fall/Spring)  
MAE 442 Senior Thesis (Spring)<sup>5</sup>  
MAE 444 Senior Project (Spring)<sup>5</sup>

---

<sup>1</sup> Required for Mechanical Engineers and Aerospace Engineers.

<sup>2</sup> MAE 322 or MAE 412 required for Mechanical Engineers.

<sup>3</sup> MAE 332 or MAE 342 required for Aerospace Engineers.

<sup>4</sup> CEE 477 is an acceptable substitute only for Mechanical Engineers who are pursuing the Sustainable Energy Certificate Program

<sup>5</sup> Year-long project with enrollment in spring semester only

**None of the Department requirements can be taken on a pass/fail or audit basis. All requests for substitution, other than those listed under the Engineering Physics Program (Section E), must be approved by the Departmental Representative in advance.**

4. The Engineering School requirements in the **humanities and social sciences** must also be met (a minimum of seven courses covering four distinct areas from the seven areas offered). See the Undergraduate Announcement for full description and distribution areas. In addition a one semester writing course is required. This course is typically completed in the 1<sup>st</sup> year.

#### **D. General Information**

Students are encouraged to elect more than the one required semester of independent work as part of their plan of study, and to participate in the extensive research programs of the Department.

Additional technical courses (which may include both undergraduate and graduate courses) can be used to pursue a specialty within the Department in greater depth.

It is also possible to participate in a variety of interdepartmental programs or expand one's studies in the humanities or social sciences beyond the seven courses required by the [School of Engineering and Applied Science](#).

#### **Professional Ethics**

Professional ethics is an important topic for all engineers. Honor code, adherence to University Regulations and adherence to rules in individual courses and laboratories are all part of our student's exposure to professional ethical matters. In addition, aspects of engineering ethics are considered in engineering courses through examples and case studies. Given that mechanical and aerospace engineering works have impact on society, the concepts of economical and safe design are foundations of ethical conduct of practitioners in the field. Students are urged to understand ethical guidelines further in the mechanical and aerospace fields as defined by the engineering societies:

ASME ( <http://www.asme.org/about-asme/governance/asme-society-policies> )  
Scroll to Policy 15.7 Ethics (available in PDF or Word format)

AIAA (<https://www.aiaa.org/about/Governance/Code-of-Ethics>)

#### **Grading Guidelines**

Course work in the MAE Department involves analysis and quantitative thinking. Student performance is usually evaluated by problem sets and examinations, and sometimes by other mechanisms such as laboratory reports, group projects, class participation, or term papers. Instructors are expected, at the beginning of the semester, to specify which types of assessment will be used in determining the final course grade, and the fraction by which each component will be weighted. Instructors should specify expectations for all assigned work, and the grades should reflect the degree to which students have met these expectations. An instructor may use a curve to help distribute final course grades. However, instructors should not use quotas, such as the number or percentage of A grades.

Following the Princeton University grading policy, guidelines for the assignment of each grade are given below:

<b>Grading Definitions</b>		
A+	Exceptional	Significantly exceeds the highest expectations for undergraduate work
A	Outstanding	Meets the highest standards for the assignment or course
A-	Excellent	Meets very high standards for the assignment or course
B+	Very good	Meets high standards for the assignment or course
B	Good	Meets most of the assignment or course
B-	More than adequate	More than adequate; shows some reasonable command of the material
C+	Acceptable	Meets basic standards for the assignment or course
C	Acceptable	Meets some of the basic standards for the assignment or course
C-	Acceptable	While acceptable, falls short of meeting basic standards in several ways
D	Minimally acceptable	Acceptable Lowest passing grade
F	Failing	Very poor performance

**Office of the Dean of the College Grading Guidelines:**

<https://odoc.princeton.edu/sites/odoc/files/Grading%20Policy%202014.pdf>

**Honors**

The determination of honors upon graduation is made by the faculty of the Department based primarily on the grade average achieved during junior and senior year in both required and elective technical courses. The student’s overall academic record and performance in independent work is also considered.

The completion of all the Departmental requirements, together with an average of 2.0\* or better in the Departmental courses will lead to a Departmental recommendation that the student graduate. The decision to deny a recommendation for graduation, to any student failing to meet the criteria above, will be made by the Departmental faculty on the basis of a full review of the student's record.

\*The grade average will be computed on the basis of equal weighing of the grades in the Departmental courses within the following numerical equivalents: A+ = 4.0, A = 4.0, A- = 3.7, B+ = 3.3, B = 3.0, B- = 2.7, C+ = 2.3, C = 2.0, C- = 1.7, D = 1.0, F = 0.0

### III. RECOMMENDED SAMPLE CURRICULA

Each student's program is planned individually in consultation with their advisor or the Departmental Representative. Sample curricula for the major options within the Department are presented later in this booklet. These sample curricula should be used as recommendations only. Individual variations are possible (and encouraged) as long as the Departmental requirements are satisfied.

#### A. Course Descriptions

Descriptions of the courses offered appear in the Undergraduate Announcement or the Graduate School Announcement, as appropriate. Additional information can be obtained by contacting the instructor in charge. The list below summarizes information on prerequisites and other background for each of the **undergraduate upper level courses** in the Department. The following information is intended to assist the student in the selection of courses in the upper class years.

- 228            Energy Solutions for the Next Century (Fall) – MAE 228 is an optional core requirement in the Sustainable Energy Certificate Program recommended for AB students. This course is open to Engineering and Liberal Arts Majors. Course will not serve as a Technical Elective. *Note: MAE 228 will be offered in spring '21 during AY 20-21.*
- 305            Mathematics in Engineering I (Fall/Spring) (Ordinary Differential Equations) - requires MAT 201 and MAT 202 as prerequisites with the possibility that MAT 202 may be taken concurrently. This course should be taken as early as possible in the student's program. **Required for all Mechanical and Aerospace Engineering majors.**
- 306            Mathematics in Engineering II (Spring) (Partial Differential Equations and Complex Variables) - requires MAE 305 as an absolute prerequisite. This course satisfies the second mathematics requirement in the department and in the Engineering Physics Program and is ***recommended for those planning to go to graduate school in engineering or applied science.***
- 321/322        Engineering Design (Fall)/Mechanical Design (Fall/Spring) - Requires only the sophomore curriculum. **MAE 321 is required for all Mechanical and Aerospace Engineering students. Either MAE 322 or MAE 412 is required for all Mechanical Engineering students.** *Note: MAE 322 will be offered in Fall during AY 20-21 and MAE 412 will remain in Spring AY 20-21).*
- 323            Aerospace Structures (Fall) – requires only sophomore Modern Solid Mechanics (MAE 223). **Either MAE 323 or CEE 361 or CEE 312 is required of all Mechanical and Aerospace Engineering students.**
- 324            Structure and Properties of Materials (Fall). SEAS 1<sup>st</sup> year requirements of chemistry, physics, and math are prerequisites. **Either MAE 324 or MSE 301 is required for all Mechanical and Aerospace Engineering majors.**

- 325 [CEE 361] Structural Analysis and Intro to Finite Element Methods (Fall) – requires only sophomore Modern Solid Mechanics (MAE 223). **Either CEE 361 or CEE 312 or MAE 323 is required of all Mechanical and Aerospace Engineering students.**
- 328 Energy for a Greenhouse-Constrained World (Spring) – Recommended for students interested in energy production and its influence on the environment. Requires MAE 221/222 as prerequisites.
- 331/332 Aircraft Flight Dynamics/Aircraft Design (Fall/Spring) - Requires the sophomore curriculum. Simultaneous enrollment in Fluid Dynamics (MAE 335) is desirable, although it is not required. **Required for Aerospace Engineering majors. Optionally, MAE 341/342 may be taken to satisfy this requirement. (MAE 331/332 and MAE 341/342 are offered in alternate years.)**
- 335 Fluid Dynamics (Fall) - requires only the sophomore curriculum as a prerequisite and Mathematics in Engineering I (MAE 305) as a co-requisite. **Required for Aerospace Engineering majors. Either MAE 335 or MAE 336 or MAE 423 is required for all Mechanical Engineering students.**
- 336 Viscous Flows (Spring) - requires only the sophomore curriculum and Mathematics in Engineering I (MAE 305) as a prerequisite. **Either MAE 336 or MAE 335 or MAE 423 is required for all Mechanical Engineering students.**
- 339/340 Junior Independent Work - Students may wish to complete a one term independent work project during their junior year. Students develop a topic of their own or select from a list of topics prepared by the faculty. They develop a work plan and select an adviser and a second reader. Registration for the course is accomplished at normal course selection time, while topic and advisor can be selected at any time prior to the end of the first two weeks of the appropriate semester. *These courses do not satisfy the senior independent work requirement of the department.*
- 339D/340D Junior Independent Work with Design - Independent work with design is intended for juniors who wish to complete a one term project. Similar to 339/340, with the principal difference that the project must incorporate aspects and principles of design in a system, product, vehicle, device, apparatus, or other design element. Registration for the course is accomplished at normal course selection time, while topic and advisor can be selected at any time prior to the end of the first two weeks of the appropriate semester. *These courses do not satisfy the senior independent work requirement of the department.*

- 341/342 Space Flight/Space System Design (Fall/Spring) – MAE 341 requires Calculus and MAE 305 or permission of instructor. MAE 342 requires MAE 305 and MAE 341 is recommended. **Required for Aerospace Engineering majors. Optionally, MAE 331/332 may be taken to satisfy this requirement. (MAE 331/332 and MAE 341/342 are offered in alternate years.)**
- 344 Biomechanics and Biomaterials: From Cells to Organisms [Spring] – MAE 344 requires MAT 103, MAT 104, PHY 103 and PHY 104 or permission of instructor.
- 345 Introduction to Robotics [Fall] – MAE 345 is an optional core requirement of the Robotics and Intelligent Systems Certificate Program. This course requires MAT 201 or 203, MAT 202 or 204, COS 126. Recommended: an introductory course in probability (ORF 309 or similar), and an introductory course in differential equations (MAE 305 or similar).
- 354 Unmaking the Bomb: Science and Technology of Nuclear Nonproliferation, Disarmament, and Verification [Spring] – MAE 354 is an optional technical elective in the Mechanical Program. This course requires PHY 101 or PHY 102 or PHY 103 or PHY 104. MAE 305 or permission of instructor.
- 412 Microprocessors for Measurement and Control (Spring) - requires MAE 221 and MAE 224, or introductory knowledge of analog and digital electronics. **Either MAE 322 or MAE 412 is required for all Mechanical Engineering students.**
- 423 Heat Transfer (Fall) - requires the standard sophomore curriculum and MAE 305 as a co-requisite. **Either MAE 423 or MAE 335 or MAE 336 is required for all Mechanical Engineering students.**
- 426 Rocket and Air-Breathing Propulsion Technology (Spring) – Prerequisites: MAE 221 and MAE 222. **Either MAE 426 or MAE 427 is required for all Aerospace Engineering students.**
- 427 Energy Conversion and the Environment: Transportation Applications (Spring) - requires only the sophomore prerequisites. **Either MAE 427 or MAE 426 is required for all Aerospace Engineering students.**
- 433 Automatic Control Systems (Fall) - Mathematics in Engineering I (MAE 305) in addition to sophomore curriculum is a prerequisite. **Required of all Mechanical and Aerospace Engineering students.**
- 434 Modern Control (Spring) - A useful complement to MAE 433, treating more advanced topics in control system design. MAE 433 is a prerequisite.
- 439/440 Senior Independent Work (Fall/Spring) – Senior independent work is intended for seniors who choose to complete a one term project. The independent work must incorporate aspects and principles of design, whether for a system, product, vehicle, device, software, or apparatus. Students develop a topic of their own or select from a list of topics prepared by the faculty. They develop a work plan and



select an adviser. ***Either of these courses will satisfy the department's senior independent work requirement.***

442 Senior Thesis (Spring) - The senior thesis is an independent study for individual students. The thesis must incorporate aspects and principles of design, whether for a system, product, vehicle, device, software, or apparatus. Work begins in the fall, but enrollment is only in spring term when a double grade is awarded. Students develop their own topic or select a topic from a list of topics prepared by the faculty. Students develop a work plan and select an advisor for their work. ***This course will satisfy the department's senior independent work requirement.***

444 Senior Project (Spring) - The senior project is a year long independent study intended for students who choose to work in teams of two or more. The team or group project must incorporate aspects and principles of design, whether for a system, product, vehicle, device, software, or apparatus. Work begins in the fall, but enrollment is only in spring term when a double grade is awarded. Groups develop their own topic or select a topic from a list of topics prepared by the faculty. Groups develop a work plan and select an advisor for their work. ***This course will satisfy the department's senior independent work requirement.***

463 Instabilities in Fluids: Linear and Non-linear Analysis of Waves and Patterns in the Environment (Spring) - MAE 463 is an optional technical elective in the Mechanical Program. This course requires 1<sup>st</sup> year Physics, 1<sup>st</sup> year Mathematics and MAE 305. (MAE 305 may be taken concurrently with the Instructor's permission).

## B. Standard Sophomore Curriculum

The recommended sophomore curriculum is common to all Departmental students, except Engineering Physics students who are allowed certain substitutions (see Section E).

(T.E. = Technical Elective)

(N.T.E. = Non Technical Elective)

### SOPHOMORE YEAR

#### FALL\*

- Mathematics
- MAE 223 Modern Solids Mechanics
- MAE 221 Thermodynamics
- N.T.E. or Materials
- N.T.E.

#### SPRING

- Mathematics
- MAE 206 Introduction to Engineering Dynamics
- MAE 222 Mechanics of Fluids
- MAE 224 Laboratory
- N.T.E.

The School of Engineering and Applied Science computer programming requirement must be satisfied by the end of the Sophomore Year.

Some sample programs are presented to indicate the major options within the Department

\*Note that the course load for this recommended curriculum is heavier in the fall than in the spring. MAE 221 has a laboratory whereas MAE 222 does not. Instead, the laboratory in the spring is listed as a separate course, MAE 224. The time commitment for MAE 224 is about one-half of a regular course. Therefore, the course load in the fall is about 5 ½ courses whereas the course load in the spring is about 4 ½ courses. The course grade in MAE 224 is determined from the laboratory course work from both the fall and spring terms.

## C. Mechanical Engineering

Students desiring an emphasis on analysis of the dynamics and control of engineering devices can follow the **Dynamics Systems** Option. Students desiring an emphasis on power generation and conversion can elect to follow the **Energy Sciences** Option. Students desiring an emphasis on design can follow the **Design** Option. It is however not necessary to rigidly follow either of these options as long as the requirements in Section II are satisfied.

### 1. Dynamic Systems (Typical program)

#### JUNIOR YEAR

##### FALL

- MAE 433 Automatic Control Systems
- MAE 321 Engineering Design (AY 2021-2022 moves to Spring)
- MAE 324 Structure and Properties of Materials or MAE 423 Heat Transfer
- N.T.E.
- N.T.E.

##### SPRING

- Mathematics Elective
- T.E. or MSE 301 Materials Science and Engineering
- CEE 312 Statics of Structures
- T.E./N.T.E.
- T.E./N.T.E.

#### SENIOR YEAR

##### FALL

- Senior Independent Work or Senior Thesis or Senior Project
- MAE 345 Introduction to Robotics
- MAE 322 Mechanical Design (or MAE 412 Trains - Spring)
- N.T.E.

##### SPRING

- Senior Independent Work or Senior Thesis or Senior Project
- MAE 412 Microprocessors for Measurement and Control (or MAE 322 - Fall)
- T.E./N.T.E.
- N.T.E.

## 2. Energy Sciences (Typical Program)

### JUNIOR YEAR

#### FALL

- MAE 433 Automatic Control Systems
- MAE 321 Engineering Design (AY 21-22 moves to Spring)
- MAE 335 Fluid Dynamics
- T.E./N.T.E.
- N.T.E.

#### SPRING

- Mathematics Elective
- CEE 312 Statics of Structures
- MSE 301 Materials Science and Engineering
- MAE 427 Energy Conversion and the Environment: Transportation Applications
- N.T.E.

### SENIOR YEAR

#### FALL

- MAE 322 Mechanical Design (or MAE 412 Trains – Spring)
- Senior Independent Work or Senior Thesis or Senior Project
- MAE 423 Heat Transfer
- N.T.E.
- N.T.E.

#### SPRING

- MAE 328 Energy for a Greenhouse-Constrained World
- Senior Independent Work or Senior Thesis or Senior Project
- MAE 412 Microprocessors for Measurement and Control (or MAE 322 – Fall)
- N.T.E.
- N.T.E.

### SUGGESTED TECHNICAL ELECTIVES

#### FALL

MAE 527 Physics of Gases I  
MAE 331 Aircraft Flight Dynamics  
MAE 341 Space Flight  
MAE 322 Mechanical Design

#### SPRING

MAE 426 Rockets and Air-Breathing Propulsion Technology  
MAE 531 Combustion  
MAE 332 Aircraft Design  
MAE 342 Space System Design

### SUGGESTED NON-TECHNICAL ELECTIVES

#### FALL

ECO 100 Introduction to Microeconomics

#### SPRING

ECO 101 Introduction to Macroeconomics

### 3. Design (Typical program)

#### JUNIOR YEAR

##### FALL

- MAE 433 Automatic Control Systems
- MAE 321 Engineering Design (AY 21-22 moves to Spring)
- MAE 324 Structure and Properties of Materials or MAE 423 Heat Transfer
- N.T.E.
- N.T.E.

##### SPRING

- Mathematics Elective
- T.E. or MSE 301 Materials Science and Engineering
- CEE 312 Statics of Structures
- MAE 340D Independent Work with Design\*
- N.T.E.

#### SENIOR YEAR

##### FALL

- Senior Independent Work or Senior Thesis or Senior Project
- MAE 345 Introduction to Robotics
- MAE 322 Mechanical Design
- N.T.E.

##### SPRING

- Senior Independent Work or Senior Thesis or Senior Project
- MAE 412 Microprocessors for Measurement and Control
- T.E./N.T.E.
- N.T.E.

*\*MAE 340D will satisfy the Additional Engineering Science Requirement in the Mechanical Program*

### 4. General Mechanical Engineering

Students not wishing to specialize in any one of the areas above (1, 2, or 3) can select any mix of the three sample curricula, provided they meet the requirements stated in Section II.

## D. Aerospace Engineering

Students wishing to concentrate their study on vehicles in air and space follow the curriculum in Aerospace Engineering (see Section II for required courses). A typical program is listed below:

### JUNIOR YEAR

#### FALL

- MAE 433 Automatic Control Systems
- MAE 3X1 Flight Dynamics\*
- MAE 321 Engineering Design (AY 21-22 will move to Spring)
- CEE 361 Matrix Structural Analysis and Intro to Finite Element Methods
- N.T.E.

\*(Note: Either MAE 331 Aircraft Flight Dynamics -or- MAE 341 Space Flight – Aircraft or Space Flight must be completed in their respective sequence for credit. If MAE 331 is elected MAE 335 should be taken concurrently and prior to MAE 426.)

#### SPRING

- MAE 3X2 Design\*
- MSE 301 Materials Science and Engineering
- MAE 412 Microprocessors for Measurement and Control
- N.T.E.

\*(Note: Either MAE 332 Aircraft Design -or- MAE 342 Space System Design - Aircraft or Space Flight must be completed in their respective sequence for credit)

### SENIOR YEAR

#### FALL

- Senior Independent Work or Senior Thesis or Senior Project
- MAE 335 Fluid Dynamics
- T.E./N.T.E.
- N.T.E.

#### SPRING

- MAE 434 (or see list of technical electives below)
- MAE 427 Energy Conversion and the Environment: Transportation Applications or MAE 426 Rocket and Air-Breathing Propulsion Technology
- N.T.E.
- Senior Independent Work or Senior Thesis or Senior Project

### SUGGESTED TECHNICAL ELECTIVES

#### FALL

MSE 302 Laboratory Techniques in Materials Science and Engineering  
COS 217 Introduction to Programming Systems

#### SPRING

ELE 201 Information and Signals  
ELE 203 Electronic Circuit Analysis, Design and Implementation  
MAE 434 Modern Controls  
MAE 546 Optimal Control and Estimation  
MAE 412 Microprocessors for Measurement and Control

## E. Engineering Physics Program

Students with a strong interest in applied science and plans for graduate study may wish to participate in the Engineering Physics Program. Students should contact the Engineering Physics Program Director when they join the Department. The program requirements include six Physics courses beyond the 1<sup>st</sup> year level (the sequence Physics 208, 305 is required), and two upperclass mathematics courses (300 and 400 level).

### SOPHOMORE YEAR

#### FALL

- Mathematics
- PHY 205 Classical Mechanics B  
or  
PHY 207 Mechanics and Waves
- MAE 221 Thermodynamics
- N.T.E.

#### SPRING

- Mathematics
- PHY 208 Principles of Quantum  
Mechanics
- MAE 222 Mechanics of Fluids
- MAE 224 Integrated Engineering Science  
Laboratory
- N.T.E.

**Physics 205/207** usually substitutes for **MAE 206**. The Departmental requirement of MAE 223 is normally met by taking MAE 325 (CEE 361) or CEE 312, or MAE 332 or MAE 342 during the Junior Year (see below).

### JUNIOR

#### FALL

- Mathematics
- PHY 301 Thermal Physics
- MAE 321 Engineering Design
- MAE 433 Automatic Control Systems
- N.T.E.

#### SPRING

- Mathematics
- PHY 304 Advanced Electromagnetism
- MSE 301 Materials Science and  
Engineering
- CEE 312 Statics of Structures
- N.T.E.

### SENIOR

#### FALL

- PHY 305 Introduction to the Quantum  
Theory
- MAE 335 Fluid Dynamics
- N.T.E.
- Begin Senior Thesis

#### SPRING

- PHY 408 Modern Classical Dynamics
- MAE 442 Senior Thesis
- MAE 412 Microprocessors for  
Measurement and Control.
- N.T.E.

If **PHY 301** is completed, this course can be used to satisfy one of the engineering science requirements.



## SUGGESTED TECHNICAL ELECTIVES

### FALL

MAE 511	Experimental Methods
MAE 521	Optics and Lasers
MAE 523	Electric Propulsion
MAE 527	Physics of Gases
PHY 406	Modern Physics II

### SPRING

MAE 328	Energy for a Greenhouse Constrained World
MAE 555	Nonequilibrium Gas Dynamics
PHY 312	Experimental Physics
PHY 405	Modern Physics I
MAE 434	Modern Control
MAE 427	Energy Conversion and the Environment: Transportation Applications

*Note: This sample Engineering Physics program is in coordination with the Mechanical Engineering program. The Aerospace program may also be followed. The Undergraduate Office can provide Requirement Forms, such as those located in the back of this booklet, for students pursuing Engineering Physics and the Mechanical Engineering Program or Engineering Physics and the Aerospace Engineering Program.*

## F. Materials Science in Engineering Program

Students wishing to concentrate in materials engineering may choose courses that satisfy both the Departmental course requirements for mechanical or aerospace engineering, and the Certificate in Materials Science and Engineering. **The certificate program requires:**

1. One core course in materials (MAE 324, MSE 301, or CEE 364);
2. One materials experimental methods course (MSE 302, MSE 505, CHM 371 or ELE 208).
3. Three additional approved courses from the materials elective list, and;
4. A two semester senior thesis on a materials topic approved by the certificate committee.

### The Departmental program(s) require:

For the Mechanical Program only: Five engineering science courses (including one materials course), mathematics elective, and three design courses (two taught design courses and one semester of senior independent work or two semesters of senior thesis). Senior independent work or senior thesis will satisfy the third design requirement. Specified materials science technical electives will qualify as engineering science technical electives in the Mechanical program. See list of engineering science courses on page 6 of this booklet.

A typical course sequence following the Mechanical Engineering Program and Materials Certificate Program is as follows:

### SOPHOMORE

#### FALL

- MAE 221 Thermodynamics
- Mathematics
- MAE 324 Structure and Properties of Materials
- MAE 223 Modern Solid Mechanics
- N.T.E.

#### SPRING

- MAE 206 Intro to Engineering Dynamics
- MAE 222 Fluid Mechanics
- MAE 224 Integrated Engineering Science Laboratory
- N.T.E.
- T.E.

### JUNIOR

#### FALL

- Mathematics Elective
- MAE 321 Engineering Design (in AY 2021-2022 will move to Spring)
- MSE 302 Materials Lab
- MAE 322 Mechanical Design – F20
- N.T.E.

#### SPRING

- MAE 412 Microprocessors for Measurement and Control
- CEE 312 Statics of Structures
- Materials T.E.
- N.T.E.

## SENIOR

### FALL

- Begin Senior Thesis
- CBE 415 Polymers
- MAE 433 Automatic Control Systems
- MAE 423 Heat Transfer
- N.T.E.

### SPRING

- MAE 442 Senior Thesis
- Materials T.E.
- N.T.E.
- N.T.E.

NOTE: Those students wishing to follow the Aerospace Engineering Program should consult with their Academic Advisor or Departmental Representative for careful selection of technical electives. For the Aerospace Program MAE 331/332 Flight Dynamics and Aircraft Design –or- MAE 341/342 Space Flight and Space Craft Design are required as well as MAE 427 Energy Conversion and the Environment: Transportation Applications or MAE 426 Rocket and Air-Breathing Propulsion Technology. MAE 335 Fluid Dynamics must be taken in a fall semester in lieu of MAE 423 Heat Transfer.

For students completing both the Mechanical and Aerospace Engineering Programs three taught design courses are required (MAE 321 Engineering Design, a Mechanical Design Course, and an Aerospace Design course) as well as senior independent work or senior thesis.

## **SUGGESTED TECHNICAL ELECTIVES:**

One of the attractive features of the program is the opportunity to choose a focus in a particular area of materials science and engineering that is of special interest to the student. For example, students may choose electives in the areas of: micro- and nano-scale materials science and engineering; biomedical materials and bioengineering; materials modeling, or structural materials.

Other areas of concentration may also be developed, depending on student interest. The technical electives may be selected from the list of courses shown below. Students may also consider to take graduate level courses for technical electives.

## **Approved Undergraduate Courses in Materials Science and Engineering:**

CHM 303/304 Organic Chemistry  
CHM 305/306 Physical Chemistry  
CHM 406 Advanced Physical Chemistry  
CHM 407/408 Inorganic Chemistry  
CBE 415 Polymers  
CBE 421 Catalytic Chemistry  
ELE 341 Solid-State Devices  
ELE 342 Principles of Quantum Engineering  
ELE 351 Electromagnetic Field Theory and Physical Optics  
ELE 352 Physical Optics  
ELE 441/442 Solid-State Physics I, II  
ELE 453 Optical Electronics  
MAE 324 Structure and Properties of Materials  
MAE 344 Biomechanics and Biomaterials: From Cells to Organisms  
PHY 304 Advanced Electromagnetism  
PHY 305 Introduction to Quantum Theory  
PHY 405 Modern Physics I: Condensed Matter Physics

## G. Interdepartmental Programs

### 1. [Program in Applications of Computing](#)

Students with interests in computer science may use upper class electives to satisfy the requirements of this program. Students should contact the PAC program Director for specific details, see Section VIII.

### 2. [Program in Applied and Computational Mathematics](#)

Students with interests in applied mathematics may use upper class electives to satisfy program requirements in Applied and Computational Mathematics. Students should contact PACM Program Director for further details, see Section VIII.

### 3. [Program in Engineering Biology](#)

Students interested in engineering biology may use upper class electives to satisfy the requirements of this program. Students should contact the EB Program Director for specific details, see Section VIII.

### 4. [Program in Engineering and Management Systems](#)

Students with a strong interest in the systems and management aspect of an engineering career may combine Departmental courses with the requirements of the Program in **Engineering and Management Systems**. Those wishing to pursue this program should see the EMS Program Director (see Section VIII) early in their academic career. A number of the program requirements satisfy Departmental requirements as well.

### 5. [Program in Engineering Physics](#)

Students interested in engineering physics may use upper class electives to satisfy the requirements of this program. There are also pre-approved substitutions in the sophomore level MAE requirements for students participating in this program (see page 18). Students should contact the EP Program Director for specific details of the program, see Section VIII.

### 6. [Program in Materials Science and Engineering](#)

Students interested in materials science and engineering may use upper class electives to satisfy the requirements of this program. Students should contact the MSE Program Director for specific details, see Section VIII.

### 7. [Program in Robotics and Intelligent Systems](#)

Students interested in robotics and intelligent systems may use upper class electives to satisfy the requirements of this program. Students should contact the RIS Program Director for specific details, see Section VIII.

8. [Program in Sustainable Energy](#)

Students interested in sustainable energy may use upper class electives to satisfy the requirements of this program. Students should contact the PSE Program Director for specific details, see Section VIII.

Sufficient flexibility is present in the Department Program to permit students to participate in other certificate programs such as the one offered by the Woodrow Wilson School.

#### IV. DEPARTMENTAL PRIZES

Six Departmental prizes are awarded each year at Class Day.

**THE GEORGE BIENKOWSKI PRIZE:** This is a financial award given in honor of George Bienkowski, former Professor and Undergraduate Representative. This award is given to a senior student(s) of sound academic standing and who has contributed to the department and engineering through their service during their career at Princeton.

**THE JOHN MARSHALL II MEMORIAL PRIZE:** This prize provides financial support for undergraduate independent work with preference given to projects in aerospace engineering. The prize is given in memory John Marshall II, '72. Prize winners are selected by the Undergraduate Faculty Committee based on written proposals submitted early in the fall. Additionally, a prize will be awarded in spring.

**DONALD JANSSEN DIKE AWARD FOR EXCELLENCE IN UNDERGRADUATE RESEARCH:** In memory of Donald Janssen (D.J.) Dike, '51. This financial award is presented to a senior(s) who in the opinion of the faculty have excelled in independent work.

**SAU-HAI LAM \*58 PRIZE IN MECHANICAL AND AEROSPACE ENGINEERING**  
Established by a donation from Professor Sau-Hai Lam, an emeritus faculty member, to the Mechanical and Aerospace Engineering Department, this prize was established to recognize graduating seniors and possibly juniors for their outstanding academic achievement.

**MORGAN W. MCKINZIE '93 SENIOR THESIS FUND AND PRIZE**  
In memory of Morgan W. McKinzie '93. The Senior Thesis fund provides financial support for independent work with preference given to projects in aircraft design and propulsion. The Senior Thesis prize is a financial award for the best Senior Thesis in the MAE Department as determined by the faculty.

**ENOCH J. DURBIN PRIZE FOR ENGINEERING INNOVATION**  
This prize, established in memory of faculty emeritus Enoch J. Durbin, is awarded to a senior in the Department where independent work or thesis has shown special interest and aptitude in engineering innovation.

## V. INDEPENDENT WORK AND STUDENT PUBLISHED PAPERS

A good indication of the interest of students in the MAE Department is the independent work they have chosen. Topics for the Class of 2019 are given below:

### Aero/Astro Engineering

Billy Andrews, *Aerodynamic Analysis and Simulation of Drag Racing Motorcycle Bodywork* (Adviser – Martinelli)

William England (Oxford), *Investigating the Effect of Separation of Row Aligned Wind Turbines on Power Production* (Adviser – Martinelli)

Teresa Irigoyen-Lopez, *Vertical Axis Wind Turbines: Analysis of Experimental Data at Full Dynamics Similarity* (Adviser – Hultmark)

Coleman Merchant, *Princeton SpaceShot: Analysis, Design & Construction of a High Performance Two-Stage Sounding Rocket* (Adviser – Martinelli)

Beni Snow, *Design, Simulation, and Testing of an ABS/GOX Hybrid Rocket Engine* (Adviser – Littman)

Ashley Barnes, Adele Dimitui, & William Kittler, *Fixed-Wing UAV Autonomous Deployment for Search and Rescue Applications* (Adviser: Majumdar)

Will Hess & Alexander Hsia, *Parameter Identification and Adaptive Control of a Fixed-Wing UAV in the Longitudinal Mode* (Adviser – Rowley)

Whitney Huang & Ramesh Gayatri/ELE, *Controlling Unmanned Aerial Vehicles in High Wind Speeds using Nano-Scale Thermal Anemometry Probes* (Hultmark & Majumdar)

### Energy and Environment

Daniel Chao, *Investigation into Computational Performance of a Multi-Modal Turbulent Combustion Model* (Adviser - Mueller)

Katherine Denner, *Identification of Lithium Deposition and Characterization of State of Charge and State of Health in Extreme Fast Charge Cells using Ultrasonic Methods* (Adviser - Steingart)

Nicholas Nelsonwood, *One-Axis Tracking for Roof-Mounted Residential Solar* (Adviser – Littman)

Nicolas Viglucci, *Design and Construction of an Energy-Efficient Living Space* (Adviser – Meggers/ARC)

Michael Whitmore, *Analysis and Closure of Dissipation Rates in a Physically Derived Reduced-Order Manifold for Turbulent Combustion* (Adviser – Mueller)



## **Materials/Biomaterials/Biomedical**

Emily Achterkirch, *Analysis of Hockey Skate Blade Holders: An Investigation into Broken Skates by Reverse Engineering* (Adviser – Kosmrlj)

Dylan Baroody, *Analysis of Soft Phononic Crystals: Using Machine Learning to Predict Compression using Transmission Data* (Adviser – Kosmrlj)

Suren Jamiyanna, *Phosphor Crystal Materials: A Design of an Anti-Counterfeiting Feature* (Adviser – Nosenchuck)

Tammy Benjapibal & Victoria Ou, *One Light Touch: A Simulation of the Sensory Cell Network in the Finger* (Adviser – Stengel)

Diego Fierros, *A New Method for Inducing Strain in Living Tissue* (Adviser – Cohen)

Hemani Kalucha, *Detecting Life on Mars - Analysis of Deep UV Raman Spectrometer with Organics in Martian Soil Matrix* (Adviser – Onstott/GEO)

Bartek Kaczmarek, *Mechanical Behavior of Pressurized Rods: 3D Shape Transformations of Rod Networks via Local Curvature Control* (Adviser – Kosmrlj & Brun/CBE)

Tanner Kliewer, *EMITD3D: A Laser Diode Array Approach to Metal Additive Manufacturing* (Adviser – Arnold)

Jacob Lisner, *Development of an Economical Device to Perform Automated Venipuncture* (Adviser – Arnold)

## **Fluids**

Mrudhula Baskaran, *A Study of Flow Separation in Micro and Milli-Channels* (Adviser – Stone & Rowley)

Sami Belkadi, *AgriFlow: The Application of Elastic Filament Velocimetry to Water Flow Measurement and Control in Hydroponic Vertical Farms* (Adviser- Hultmark)

## **Applied Physics/Plasma Physics/Lasers & Optics**

William Kelly, *Gene Ark Design* (Adviser – Choueiri)

Kendall Ratter, *TAG Lens Laser Experimentation* (Adviser – Arnold)

## **Humans, Machines, Components, and Controls**

Nora Bradley, *Injection Molding: Process and Design Principles for 3D Printed Molds* (Adviser – Littman)

Lydon Kersting, *xPLOR: An Expandable Pack for Lightweight Outdoor Refuge* (Adviser – Kosmrlj)

Larry Loprete, *Two Degree of Freedom Motion Simulator Design, Fabrication, and Analysis* (Adviser – Littman)

Jackie Macharashvili, *Measuring the Acoustics of the Interior of a Tesla 3 Automobile* (Adviser – Choueiri)

Caleb Owens, *Reconstructing the Past: Analysis, Design and Assembly of Arago's Disk* (Adviser – Littman)

Jorge Reyes, *An Affordable Navigation and Weed Detection System for Farming Robot* (Adviser – Nosenchuck)

Nikita Turley, *ElectroMagnetic Intake Valve Actuation Using a Subwoofer* (Adviser – Nosenchuck)

David Wu, *Intelligent Audio Beam Locking for Source-Listener Isolation (one-semester)* (Adviser – Choueiri)

Robert Buline, Robbie Cohen, & Fred Zheng, *reOcean: An Active System for Removing Waste from the Oceans* (Adviser – Nosenchuck)

Spencer Kyrzka, Connor Roettig, Joshua Teves, & Max Veronneau, *Hybrid Performance Golf Cart: Examining the Feasibility of Low-Budget Hybrid Engines* (Adviser: Nosenchuck)

Mario Liu & Nadir Noordin, *Autonomous Quadcopter Navigation using Depth Camera and Real-Time Kinematic GPS* (Adviser: Kolemen)

Curtis Merrill, Joseph Puryear, & Serg Zhelezniak, *Dynamic Thrust and Vector Control of a Small Scale Turbojet Engine* (Adviser: Kolemen)

Jeremy Spiezio & Matias Supervielle, *The Sound of Silence: A Preliminary Investigation into the Effects of Blade Row Spacing in Counter-Rotating Propellers on the Sound Intensity in the Near-Field* (Adviser: Nosenchuck)



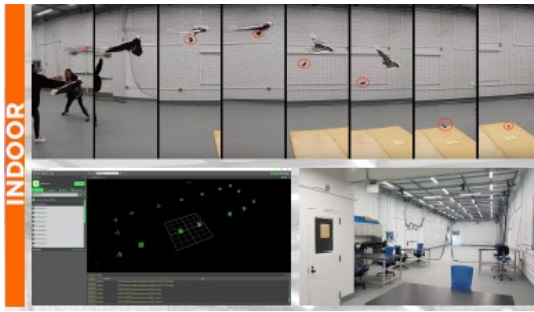

*Barnes, Dimitui, Kittler (Indoor and Outdoor Testing)*

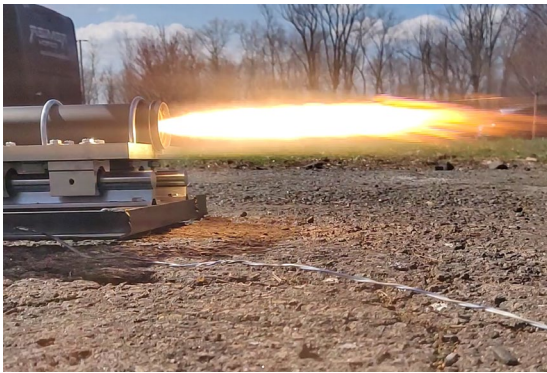

*Snow (Engine)*

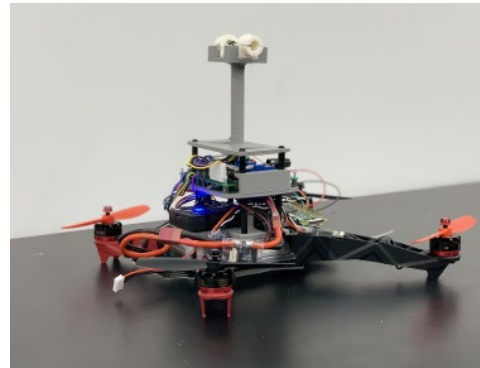

*Huang and Ramesh (Custom Built Drone)*



*Nelsonwood (Test Stand)*



*Baroody (Porosity Triangular Mold Under 3 Pressure States)*

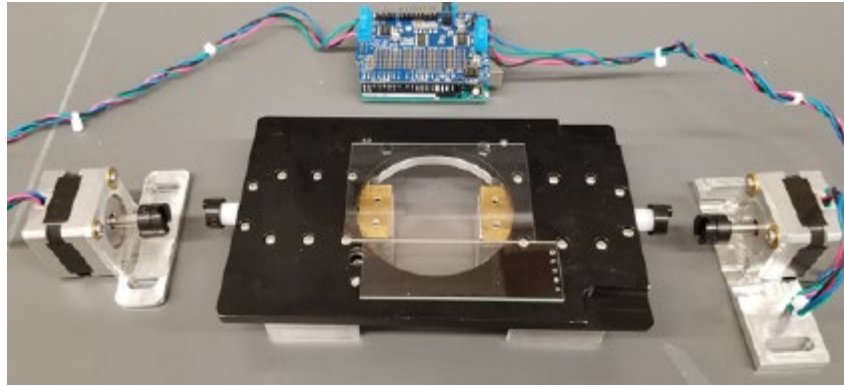

*Fierros (Final Device)*

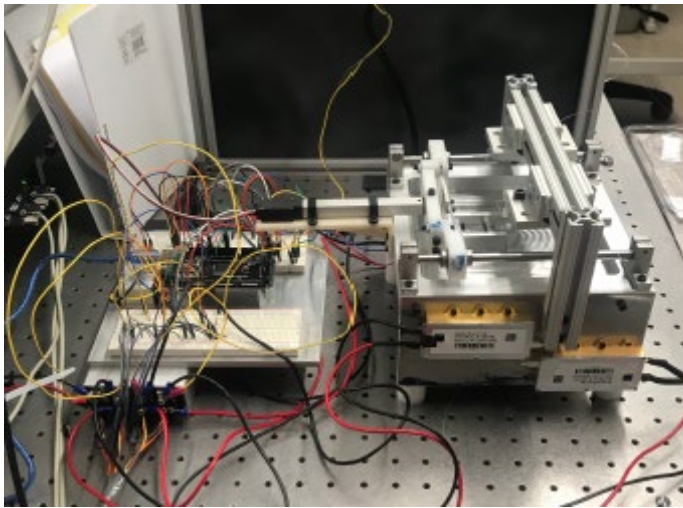

*Kliewer (Finished Machine)*

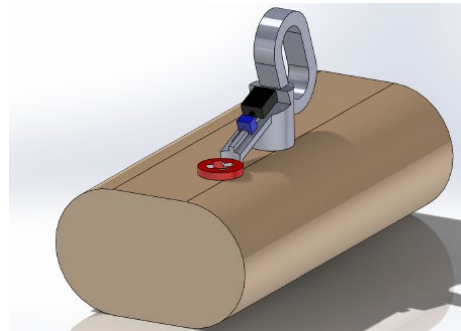

*Lisner Device*



*Kersting (Flexible Backpack and Opened as Shelter)*





*Kelly (Final Design)*



*Loprete (Completed Motion Simulator)*



*Reyes (Experimental Weed Detection Set-Up)*



*Kryczka, Roettig, Teves, Veronneau (Final Cart Design)*



*Buline, Cohen, Zheng (Full System Retrieving Garbage)*



*Merrill, Puryear, Zhelezniak (Final Experimental Assembly)*

**Independent Work Projects or Senior Thesis research may result in a published paper with the student's advisor. Here are some examples of student published papers:**

- On Robustness and Leadership in Markov Switching Consensus Networks, (S.H. Cen, V. Srivastava and N.E. Leonard) *Proc. IEEE Conference on Decision and Control*, Melbourne, Australia, 2017
- ALD-Grown SEE Layer Studies for Microchannel Plates for Photodetection, (O. Shende, A. Mane, and J. Elam) 2017 Materials Research Society Spring Meeting.
- Fabrication of High Performance Flexible Silver Zinc Wire Battery, (D. Steingart, M. Wang) *Advanced Electronic Materials*, 2016.
- Design and Construction of a 76m Long-Travel Laser Enclosure for a Space Occulter Testbed, (N.J. Kasdin, D. Echeverri, et. al.) *Proc. SPIE*, Volume 9912, 2016.
- Swimming Speed has Little Impact on Fish-like Swimming Performance, (A. Smits, N. Wei, et. al.) presented at the 69th Meeting of the American Physical Society Division of Fluid Dynamics, Portland, OR, November, 2016.
- Passive Boundary Layer Separation Control on a NACA2415 Airfoil at High Reynolds Numbers, (A. Parikh) presented at the 69<sup>th</sup> Annual American Physical Society Division of Fluid Dynamics Meeting, Portland, OR, November, 2016.
- Technology Progress of a Ferrofluid Deformable Mirror with Tunable Nominal Optical Power for High-contrasting Imaging, (N.J. Kasdin, D. Echeverri, I.R. Cleff, et. al.), *Proc. SPIE*, Volume 9605, 2015.
- *In Operando* Electrochemical-Acoustic Time-of-Flight Analysis of Zinc Electroplating, (D. Steingart, M. Wang, et. al.) presented at the Materials Research Society Fall 2015 Meeting in Boston, MA.
- Evolution of ion-induced nanoparticle arrays on GaAs surfaces with O. Shende, M. Kang, I. Beskin, A. A. Al-Heji, S. Huang, S. Jeon, and R. S. Goldman. In *Applied Physics Letters* 104. 2014.
- Direct Fusion Drive for a Human Mars Orbital Mission, M. Paluszek, K. Griffin, et.al. *International Astronautical Congress, IAC-12, C4, 7-C3.5,10*. Toronto, Canada, 2014.
- Community Charging Stations in Rural Sub-Saharan Africa: Commercial Success, Positive Externalities, and Growing Supply Chains, *Energy for Sustainable Development*, in *Energy for Sustainable Development*, December 2014 (N. Schiavone, P. Kemeny, P.G. Munro, G. Van Der Horst, and S. Williams)
- Modeling Unsteady Forces and Pressures on a Rapidly Pitching Airfoil, *APS Division of Fluid Dynamics*, November 2014 (N. Schiavone, S. Dawson, C. Rowley, and D. Williams)

- Virtual Gamma-ray Spectrometry for Template-Matching Nuclear Warhead Verification, 56<sup>th</sup> Annual Meeting of the Institute of Nuclear Materials Management, July 2014 (J. Schirm, A. Glaser)
- Development of a Mars Ascent Vehicle Using In-Situ Propellant Production, 2014 AIAA Space Ops Conference, May 2014, Pasadena, CA (L. Paxton, D. Vaughan)
- Propagation of Orbital-Angular-Momentum Carrying Beams Through a Perturbing Medium, Journal of Optics, September 13 (A. Chaibi, C. Mafusire, A. Forbes)
- In The Dance Studio: Analysis of Human Flocking, 2012 American Control Conference, Montreal (N. Leonard, G. Young, K. Hockgraf, D. Swain, A. Trippe, W. Chen, and S. Marshall)
- Experimental Characterization of Three-Dimensional Corner Flows at Low Reynolds Numbers, J. Fluid Mechanics, Vol. 707, September 2012, pp 37-52 (J. Sznitman, L. Guglielmini, D. Clifton, D. Scobee, H.A. Stone, and A.J. Smits)
- Localized Microwave Plasma Grid by Laser-Designation, AIAA-2011-4000, 42<sup>nd</sup> Plasmadynamics and Lasers Conference in conjunction with the 18<sup>th</sup> International Conference on MHD Energy Conversion (ICMHD), Honolulu, Hawaii (M.R. Edwards et al.)
- Design and Analysis of a Single-Stage Hypersonic Concept for Ultra-Rapid Global Travel, 15<sup>th</sup> AIAA International Space Planes and Hypersonic Systems and Technologies Conference, April 2008, Dayton, Ohio, Paper No. AIAA 2008-2521, (J.B. Glass, A. Mackowski, S. Plucinski, S. Sherman, C.A. Teichner and A. Van Hoek, D. Cummins, T. Conbeer, R. Mellish, B. Vigil, J. Vogel, Z. Xia, and K. Bowcutt)
- Eddy Hunting in Compressible Boundary Layers using DNS Data, 59<sup>th</sup> APS Division of Fluid Dynamics Meeting, November 2006, Tampa, Richdale, (G.C. Richdale, M.P. Martin, and D. Silver)
- Leo Constellation Design Using the Lunar L1 Point, 14<sup>th</sup> AAS/AIAA Space Flight Mechanics Conference, February 2004, Maui, Hawaii, Paper No. AAS 04-248, (J. Chase, N. Chow, E. Gralla, N.J. Kasdin)
- Hovercraft Satellite Simulation Test-Bed, 14<sup>th</sup> AAS/AIAA Space Flight Mechanics Conference, February 2004, Maui, Hawaii, Paper No. AAS 04-300, (B. Essenberg, J. Sarokhan, N.J. Kasdin)
- Integrated Robotic Team for Martian Water Collection, 2002 RASC-AL Student Design Competition, Cocoa Beach, FL, November 2002, (K. Alemany, K. Bethke, N. Bhatt, B. Bollman, J. Viventi, D. Nosenchuck, S. Lyon, M. Littman)
- Control of Optical Phase and Amplitude in a Coronagraph using a Michelson Interferometer, August 2002, SPIE Conference on Future EUV-UV and Visible Space Astrophysics Missions and Instrumentation, Proceedings (Vol. 4854), (M. Littman, M. Carr, J. Leighton, E. Burke, D. Spergel, N.J. Kasdin)



## VI. POST-GRADUATION PLANS

An indication of the career plans of the graduates of the Department obtained from the immediate post graduation plans of the Classes of 2015 through 2019 are charted below.

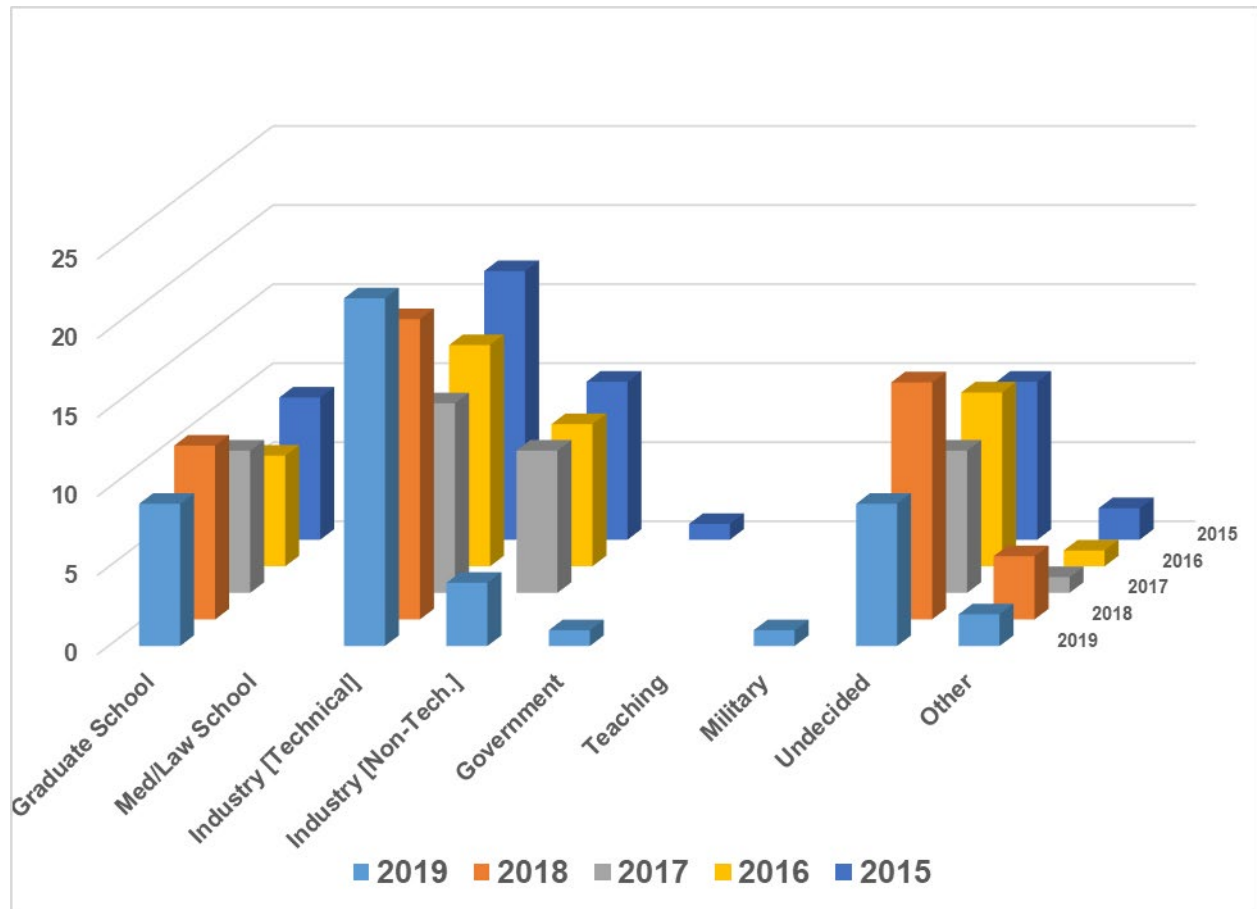

## VII. FACULTY RESEARCH INTERESTS

- Craig B. Arnold      Research in the general area of materials synthesis and processing with interests in energy storage and conversion, additive and 3D manufacturing, microfluidics, and laser processing. Current projects include laser-induced microfluidic jetting, 3D and additive manufacturing of metal alloys, mechanics of batteries, electrochemical energy harvesting, and advanced optics for real-time 3D imaging. Research includes a mix of both experimental and theoretical projects ranging from fundamental science through product commercialization.
- Edgar Y. Choueiri      Spacecraft propulsion, plasma dynamics, astronautics, space plasma physics, acoustics, 3D audio, sound perception and localization.
- Daniel J. Cohen      We do a variety of bioengineering, biomechanics, and biomaterials research with living tissues and engineered micro-devices. Cells are easy and fun to work with and we will teach you what you need to know! Current projects include micro-patterning of tissues, studying the swarm behaviors of hundreds of thousands of cells as they heal injuries, building tools to apply forces and electric fields to cells, and more. Our work is highly interdisciplinary and there will be many opportunities for independent projects. Learn more about our work and projects at [CohenGroup!](#)
- Luc Deike      Research focuses on multi-phase turbulent systems, involving waves, drops and bubbles in turbulent environment. We develop laboratory and numerical experiments to explore the physics at play and build simple models. Our work is motivated by environmental and industrial applications, as diverse as the statistics of waves in the ocean, wave impact on structures, floating ice sheet, gas transfer by surface breaking waves in the ocean, spray dynamics and cloud formation in the atmosphere.
- Lamyaa El-Gabry      Research interests are in gas turbine aerodynamics and heat transfer. Experimental research has focused on the aerothermal performance of film cooling flows through detailed measurements of velocity, turbulence, temperature, and heat transfer. Ongoing studies include experimental/computational fluid dynamics modeling of film cooled nozzle guide vanes and development of cooling geometry to improve film effectiveness.
- Alexander Glaser      Research focuses on the technical aspects of nuclear-energy use and related fuel-cycle technologies, and specifically on questions related to the proliferation of nuclear weapons. Analyses are supported by computer simulations of reactors. Additional projects on nuclear nonproliferation and disarmament, including nuclear forensics and nuclear archaeology. Web: <http://nuclearfutures.princeton.edu>

Mikko Haataja	Research focuses on theoretical and computational materials science and physical biology. Current work includes studies of microstructure formation during solid-solid phase transformations, dislocation dynamics, mechanics of bulk metallic glasses, and evolving microstructures in biology.
Marcus Hultmark	Research interests are in experimental and theoretical fluid mechanics. Problems involving heat, mass and momentum transfer are being studied, including atmospheric flows, wind energy and bio inspired flows. Most work involves water or wind tunnels and some involve unique instrumentation.
Jesse Jenkins	Energy systems engineer with a focus on the rapidly evolving electricity sector, including the transition to zero-carbon resources, the proliferation of distributed energy resources, and the role of electricity in economy-wide decarbonization. Jesse's research focuses on improving and applying optimization-based energy systems models to evaluate low-carbon energy technologies, policy options, and robust decisions under deep uncertainty.
Yiguang Ju	Energy conversion by using alternative fuels. Engine knock and detonation. Non-equilibrium plasma assisted combustion for propulsion and fuel reforming. Advanced laser diagnostics and imaging of combustion processes. Multi-scale modeling of combustion in propulsion systems. Synthesis of functional nanomaterials for energy storage and optical imaging.
Egemen Kolemen	Research focuses on the application of dynamics and control theory to experimental plasma physics, primarily to address the challenges of fusion reactor design. I analyze the dynamics of complex plasma phenomena using applied mathematics and control theory with the aim of designing and implementing novel control techniques, which I then use to build real-time control systems from the ground up. Current research includes reduction of the heat flux to the fusion reactor vessel using advanced magnetic divertor configuration, detachment, and radiation control; and disruption avoidance against instabilities such as Neoclassical Tearing Modes and Resistive Wall Modes.

Andrej Kosmrlj	Research combines elements of mechanics, physics and biology. Research projects include design and mechanics of metamaterials with unusual mechanical properties; biomechanics; mechanics in morphogenesis during embryo development; statistical mechanics of microscopic structures in the presence of thermal fluctuations and disorder, with potential applications for flexible electronics, sensitive force sensors or micro-actuators.
Chung King Law	Research interests include droplet and spray combustion, formulation of synthetic and high-energy fuels, flame structure studies, ignition and extinction phenomena, soot formation in flames, climatic issues including hydrogen combustion and safety, combustion synthesis of materials, laser diagnostics and numerical simulation of flames.
Naomi E. Leonard	Control and dynamics with application to movement and decision-making of technological systems, such as autonomous vehicles and robotic systems, and to natural systems, such as animals. Biology-inspired, coordinated control of multi-vehicle networks. Mobile sensor networks and environmental monitoring. Modeling and analysis of collective motion and collective decision-making in animal groups such as fish schools, honeybee swarms, and zebra herds. Decision dynamics of mixed teams of humans and robots.
Michael G. Littman	Two main activities: (1) Modern manufacturing tools (3D printers, laser cutters, CNC mills) for use in STEM education and (2) the Terrestrial Planet Finder. The NSF-funded STEM work is connected to Prof. Littman's history of engineering interests. It involves developing devices and activities for secondary school students to re-create historic inventions such as Joseph Henry's electric motor or Alexander Bell's telephone using modern manufacturing tools. Students are then challenged to develop their own inventions based on concepts learned through re-creation. The TPF work involves the use of adaptive optics to correct for errors in telescope mirror shape and reflectivity. The objective is to minimize the effect of diffraction to improve visibility of faint astronomical objects including earth-like planets around nearby stars. Prof. Littman also supervises student projects for improving laboratory experiments and lecture demonstrations for his courses on microcomputer control, history of engineering, and motorcycle design.
Anirudha Majumbar	My research interests lie in developing algorithmic tools that push highly agile robotic systems to the brink of their hardware limits while ensuring that they operate in a provably safe manner despite uncertainty in their environment and dynamics.
Luigi Martinelli	Computational Fluid Dynamics for high Reynolds number flow on complex domains: theory, software implementation on HPC systems, and utilization. Aerodynamic shape optimization for aeronautical and

marine applications. Applied Aero/Hydro dynamics for aircraft, ships, cars and wind/tidal turbines.

- Julia Mikhailova      Attosecond science, generation of attosecond pulses, light-matter interaction; ultrafast optics, generation and applications of ultrashort light pulses with the controlled carrier-envelope phase; optical parametric chirped pulse amplification; high-field physics, relativistic laser-plasma interaction, relativistic high-harmonic generation, laser-driven particle acceleration, quantum optics, entanglement of quantum states, biphoton states in spontaneous parametric scattering of light, filamentation of light packets in air and solids; waveguides, nonlinear fiber optics, photonic-crystal fibers; nanowaveguide sensors.
- Michael E. Mueller      Computational modeling and simulation of turbulent reacting flows. Specific interests include multi-modal turbulent combustion, pollutant emissions, and combustion-affected turbulence. Uncertainty quantification for turbulent reacting flow simulations. Numerical methods for complex geometries and algorithms for heterogeneous high-performance parallel computing. Applications to reciprocating engines, aircraft engines, and stationary gas turbines.
- Daniel M. Nosenchuck      Experimental/computational fluid mechanics and instrumentation. Active control of boundary layer instabilities and turbulence. Product design and manufacture, rapid prototyping; entrepreneurship.
- Clarence Rowley      Dynamical systems modeling of fluids, both to better understand the physics of complex flows, and to control these flows. Model reduction and symmetry reduction for bifurcation analysis and control. Numerical methods, and applications of geometric methods in fluid mechanics.
- Alexander J. Smits  
*(Emeritus)*      The study of turbulent flows, new surfaces for drag reduction, fish-like propulsion systems, wind turbines, and the development of new experimental techniques.
- Robert H. Socolow  
*(Emeritus)*      Carbon management: Reconciling a world dominated by fossil fuels for another century with the constraints of the atmospheric greenhouse. Engineering studies of carbon capture during the production of electricity, hydrogen, and synthetic hydrocarbon fuels from coal and biomass. Opportunities for carbon dioxide storage. Energy efficiency, renewable energy, and nuclear power.

- Robert F. Stengel      Aerospace dynamics and control, robotics and intelligent systems, optimal control and estimation, systems biology.
- Howard A. Stone      Research interests are in fluid dynamics, widely interpreted, and include a combination of experiment, theory, simulation and modeling. The studies are oriented towards flow problems where viscous effects are significant. The Stone group has active projects involving multiphase flows in microfluidic devices, thin film flows, high-speed imaging of flow phenomena, investigations in bioengineering such as cellular-scale hydrodynamics, formation of biofilms, etc. Many projects occur at the boundaries of traditional disciplines. Stone is also interested in various industrial applications and thinking about ways modern communications and advances in small devices (mechanical, electrical, etc.) can augment and inform traditional engineering disciplines.
- Szymon Suckewer  
*(Emeritus)*      Prof. Suckewer and his group's interest and research revolve around ultra-short pulse lasers and their applications. Especially exciting are the medical applications of fsec-type lasers (in 100 fsec light travels a distance equal to 1/3 the diameter of a strand of human hair), which due to their very short pulses they act like very sharp scalpels. Prof. Suckewer's group is using such lasers for a new type of eye surgery and for dermatology treatments. They are also using these types of lasers, but with extremely high intensity, for the development of X-ray lasers for applications in X-ray microscopy of biological cells. Besides applications and development of a new type of lasers they are also involved in improving the performance of internal combustion and jet engines by means of development of high volume plasma traveling spark ignition (TSI).

#### FACULTY AVAILABLE FOR CONSULTATION:

- Barrie S. H. Royce  
*(Emeritus)*      Present research is concerned with the mechanical properties of materials on the nanometer length scale. Of particular interest is study of materials in a biological environment and MEMS structures. Mechanical testing techniques are being developed to look at elastic and plastic properties of nano- or micro-structured materials, their resistance to fatigue environments, and the effects of surface morphology on cell-material interactions.

## VIII. WHO TO SEE FOR MORE INFORMATION

Normally, first year students who choose to pursue Engineering in this Department have their course selections for the Sophomore year approved by the Departmental Representative. Sophomore Class Advisors for course selections are: Prof. Craig Arnold (A-G); Prof. Dan Nosenchuck (H-M); Prof. Michael G. Littman (N-S); Prof. Luigi Martinelli (T-Z).

Upperclass students are assigned an academic advisor in the Department according to their area of interest (Aerospace Engineering, Mechanical Engineering, Interdepartmental Certificate Programs). The advisor is available throughout the academic year to 1) discuss and advise students on course selections etc. 2) approve course selection score worksheets and course change forms. Students should feel free to discuss any questions related to their academic program with the Departmental Representative.

Departmental Representative:	M.G. Littman Ext. 8-5198	D-202A E-Quad. <a href="mailto:mlittman@princeton.edu">mlittman@princeton.edu</a>
Undergraduate Administrator:	Jo Ann Love Ext. 8-5169	D-230 E-Quad <a href="mailto:jolove@princeton.edu">jolove@princeton.edu</a>
Academic Program Assistant	Theresa Russo Ext. 8-7972	Atrium 31, J-Wing, E-Quad <a href="mailto:tar3@princeton.edu">tar3@princeton.edu</a>

### Upperclass Advisors:

#### *Class of 2020:*

Professor Daniel Cohen, 107 Hoyt, [djctwo@princeton.edu](mailto:djctwo@princeton.edu)

Professor Mikko Haataja, D404C, E-Quad, Ext. 8-9126, [mhaataja@princeton.edu](mailto:mhaataja@princeton.edu)

Professor Marcus Hultmark, D222, E-Quad, Ext. 8-0314, [hultmark@princeton.edu](mailto:hultmark@princeton.edu)

Professor Yiguang Ju, D330, E-Quad, Ext. 8-5644, [yju@princeton.edu](mailto:yju@princeton.edu)

Professor Andrej Kosmrlj, D414, E-Quad, Ext. 8-8613, [andrej@princeton.edu](mailto:andrej@princeton.edu)

Professor Michael Littman, D202-A, E-Quad, Ext. 8-5169, [mlittman@princeton.edu](mailto:mlittman@princeton.edu)

Professor Ani Majumdar, D202B, E-Quad, Ext. 0854, [ani.majumdar@princeton.edu](mailto:ani.majumdar@princeton.edu)

Professor Dan Nosenchuck, D302-B, E-Quad, Ext. 8-5136, [dan@princeton.edu](mailto:dan@princeton.edu)

### *Class of 2021:*

Professor Craig Arnold, D410, E-Quad, or Bowen 320, Ext. 8-0250, [cbarnold@princeton.edu](mailto:cbarnold@princeton.edu)

Professor Luc Deike, D428, E-Quad, Ext. 8-7920, [ldeike@princeton.edu](mailto:ldeike@princeton.edu)

Professor Lamyaa El-Gabry, D324, E-Quad, Ext. 8-1916, [lelgabry@princeton.edu](mailto:lelgabry@princeton.edu)

Professor Yiguang Ju, D330, E-Quad, Ext. 8-5644, [yju@princeton.edu](mailto:yju@princeton.edu)

Professor Michael Littman, D202-A, E-Quad, Ext. 8-5169, [mlittman@princeton.edu](mailto:mlittman@princeton.edu)

Professor Luigi Martinelli, D302-C, E-Quad, Ext. 8-6652, [gigi@phantom2.princeton.edu](mailto:gigi@phantom2.princeton.edu)

Professor Dan Nosenchuck, D302-B, E-Quad, Ext. 8-5136, [dan@princeton.edu](mailto:dan@princeton.edu)

Professor Clarence Rowley, D232, E-Quad, Ext. 8-7321, [cwrowley@princeton.edu](mailto:cwrowley@princeton.edu)

### **Engineering Biology:**

Professor Michael Littman, D202-A, E-Quad., Ext. 8-5198

### **Engineering Physics:**

Professor Michael Littman, D202-A, E-Quad., Ext. 8-5198

### **Robotics and Intelligent Systems:**

Naomi Leonard (MAE) – [naomi@princeton.edu](mailto:naomi@princeton.edu)

Thomas Funkhouser (COS) - [funk@cs.princeotn.edu](mailto:funk@cs.princeotn.edu)

Naveen Verma (ELE) – [nverma@princeton.edu](mailto:nverma@princeton.edu)

### **Sustainable Energy:**

Professor Yiguang Ju, D330, E-Quad, Ext. 8-5644



## **Student Departmental Committee and Other Student Committees:**

### ***MAE Undergraduate Student Council/AIAA/ASME: (Current Officers)***

Co-Presidents (outgoing AY 19-20): *Sam Dale '20* [sdale@princeton.edu](mailto:sdale@princeton.edu)  
*Alexandra Koskosidis '20* [ajk2@princeton.edu](mailto:ajk2@princeton.edu)  
President (incoming AY 20-21): *Shalaka Madge '21* [shalakam@princeton.edu](mailto:shalakam@princeton.edu)

### ***ASME (American Society of Mechanical Engineers) and AIAA (American Institute of Aeronautics and Astronautics) (Faculty Advisers):***

Faculty Advisor AIAA: *Michael Mueller* [muellerm@princeton.edu](mailto:muellerm@princeton.edu)  
Faculty Advisor ASME: *Mikko Haataja*, [mhaataja@princeton.edu](mailto:mhaataja@princeton.edu)

### ***SAE and Formula SAE (Society of Automotive Engineering): Princeton Racing Electric***

Faculty Advisor: *Yiguang Ju*, [yju@princeton.edu](mailto:yju@princeton.edu)  
E-mail: [pre@princeton.edu](mailto:pre@princeton.edu)  
Co-Presidents: *Michael Hauge '21* [mhauge@princeton.edu](mailto:mhauge@princeton.edu)  
*Kevin Tong '22* [ktong@princeton.edu](mailto:ktong@princeton.edu)

## **Interdepartmental Programs (For Current Academic Year):**

### Program in Applied & Computational Mathematics

Director: Peter Constantin – [const@math.princeton.edu](mailto:const@math.princeton.edu)  
205 Fine Hall, Phone: 8-6303

### Program in Applications of Computer

Director: Jaswinder P. Singh – [jps@princeton.edu](mailto:jps@princeton.edu)  
423 Computer Science, Phone: 8-5329

### Program in Engineering Biology

Director: Celeste Nelson – [celesten@princeton.edu](mailto:celesten@princeton.edu)  
303 Hoyt Chemical Laboratory, Phone 8-8851

### Program in Engineering and Management Systems

Director: Amir Ali Ahmadi – [a\\_a\\_a@princeton.edu](mailto:a_a_a@princeton.edu)  
Sherrerd Hall 329, Phone: 8-6416

### Program in Engineering Physics

Director: Stephen A. Lyon – [lyon@princeton.edu](mailto:lyon@princeton.edu)  
B-428 E-Quad, Phone: 8-4635

### Program in Materials Science & Engineering

Director: Alejandro W. Rodriguez – [arod@princeton.edu](mailto:arod@princeton.edu)  
B318 E-Quad, Phone 8-8962

Program Coordinator: Sandra Lam – [sclam@princeton.edu](mailto:sclam@princeton.edu)  
Bowen Hall 323, Phone: 8-6704

### Program in Robotics and Intelligent Systems

Co-Directors: Thomas Funkhouser (COS) - [funk@cs.princeton.edu](mailto:funk@cs.princeton.edu)  
Naveen Verma (ELE) – [nverma@princeton.edu](mailto:nverma@princeton.edu)  
Naomi Leonard (MAE) – [naomi@princeton.edu](mailto:naomi@princeton.edu)

### Program in Sustainable Energy

Director: Yiguang Ju – [yju@princeton.edu](mailto:yju@princeton.edu)  
D-330 E-Quad, Phone: 8-5644

## **Study Abroad and Foreign Exchange:**

Engineering is an international enterprise and American companies undertake projects on all continents. In addition, the globalization of enterprises frequently distributes the manufacturing and research activities of a company to several countries. Well-prepared engineers should, therefore, be familiar with the different cultures in which their expertise may be used. The Study Abroad program of the University provides an excellent opportunity to begin this process while obtaining credits from a foreign university that will count towards your degree program. Because the academic year follows different schedules in different countries and hemispheres, you will need to explore the most suitable time to enter such a program. It may be possible to combine a summer program in a country with at least one term of study in your discipline. In this context, some students with advanced standing have used the spring term of the sophomore year followed by summer study whereas others have used the fall term of the junior year. Several foreign universities prefer visiting students to attend for a full academic year as their courses run through the year and the examinations occur at the end of this period.

The Department encourages students who are interested in this educational opportunity to discuss it with their advisor; the Department Undergraduate Representative, Professor Michael G. Littman; Dean Peter Bogucki of the School of Engineering and Applied Science; and Dean Gisella Gisolo, Office of the Dean of the College, Office of International Programs. You may also access the Study Abroad home page <https://www.princeton.edu/oip/about/people/>. Planning should start as early in the academic process as possible so that your degree program can be designed to accommodate this period of foreign study.

In the past few years, MAE students have studied at the University of Cape Town/South Africa, the University of Auckland/New Zealand, the University of Melbourne/Australia, the University of Sydney/Australia, Indian Institute of Technology/India, the University of Edinburgh/Scotland, University of Manchester/United Kingdom, University of Canterbury/New Zealand, and the University of Cantabria/Spain.

### *Foreign Exchange:*

The School of Engineering and Princeton University have established two Foreign Exchange programs. MAE students have recently participated in the Oxford University Exchange Program in the United Kingdom spending their Junior year abroad. A program has also been established with Ecole Centrale in Paris which may focus on energy studies followed by a summer internship in an energy related industry. A strong background in French is encouraged. There is also a program established with Delft University of Technology in the Netherlands and a newly established program with Tsinghua University in China.

**Study Abroad Contact Information:**

Professor Michael G. Littman  
D202-A, E-Quad  
8-5198,  
[mlittman@princeton.edu](mailto:mlittman@princeton.edu)

Dean Peter Bogucki  
C205, E-Quad  
8-4554  
[bogucki@princeton.edu](mailto:bogucki@princeton.edu)

Office of International Programs  
Study Abroad  
Simpson International Building  
8-5524

**Study Abroad Homepage:**

<http://www.princeton.edu/oip/sap/>

**Study Abroad Meet with an Advisor:**

<http://www.princeton.edu/oip/about/appointments/>

**APPENDIX I**  
**REQUIREMENT FORMS**

## Aerospace Engineering Program

<b>Name:</b>	<b>Year:</b>	<b>Advisor:</b>
--------------	--------------	-----------------

**HUMANITIES AND SOCIAL SCIENCE REQUIREMENTS: (total of 7 required in four distinct areas)**

Distribution Area	Course #	Sem/Yr	Ck	Course #	Sem/Yr	Ck	Course #	Sem/Yr	Ck
(EC) Epist & Cogn									
(EM) Ethic & Moral									
(SA) Social Analysis									
(HA) Historical Analysis									
(LA) Literature & Arts									
(FL) Foreign Language									
(CD) Culture & Difference									

**ENGINEERING SCHOOL REQUIREMENTS (total of 8 courses required or AP credit)**

Course	Check	Semester/Yr	Course	Check	Semester/Yr
MAT 103			PHY 103 or 105*		
MAT 104			PHY104 or 106*		
MAT 201 or 203*			CHM 201 or 203*		
MAT 202 or 204			COS 126*		

**DEPARTMENTAL REQUIREMENTS (15 courses required)**

Course	Check	Semester/Yr	Course	Check	Semester/Yr
MAE 223			MAE 221		

**Upper Level Departmental Requirements:**

( ) = Number of Courses Required

	Course	Semester/Yr	Course	Semester/Yr	Course	Semester/Yr
<b>Materials (1)</b>	MAE 324 or MSE 301					
<b>Design (3)**</b>	MAE 321		MAE 332 or 342			
<b>Required Technical</b>	MAE 331 or 341		CEE 361 or 312 or MAE 323		MAE 335	
<b>Electives (5)</b>	MAE 433		MAE 426 or 427			
<b>Senior IW -or-</b>	MAE 439		MAE 440		One Semester of independent work is required. More than one suggested.	
<b>Senior Thesis -or-</b>	MAE 442					
<b>Senior Project</b>	MAE 444					
<b>Aero Requirements: Checklist</b>	MAE 321, MAE 331/341 or MAE 332/342, MAE 335, MAE 427/426, MAE 433, Materials, CEE361 or CEE312 or MAE 323, Sr. IW or Sr. Thesis or Sr. project - satisfies 3rd Design Requirement					

	Course	Semester/Yr	Course	Semester/Yr	Course	Semester/Yr
<b>Free Electives/</b>						
<b>Additional Courses</b>						
<b>(Non-Tech Electives)</b>						
<b>Writing Requirement (1)</b>						

**Total # of Courses Must Equal 36**  **Certificate Program(s):**

\*See back page for approved alternate courses

\*\*Third Design requirement will be satisfied by either Senior Independent Work, Senior Thesis, or Senior Project

OUTSIDE COURSES (If Applicable)			
Princeton Equivalent Course #	Name of University	Semester & Year	Comments

**Notes:**

**Substitutions not requiring Departmental Representative's Approval:**

**Math:**

EGR 192 replaces MAT 201 or MAT 203

**Physics:**

PHY 107/108/109 sequence "General Physics" may replace the PHY103/105 or PHY 105/106 sequence

EGR 191 replaces PHY 103 or PHY 105

EGR 193 replaces PHY 104 or PHY 106

**Chemistry:**

CHM 207 Advanced General Chemistry: Materials Chemistry

NOTE: ISC 231, 232 (Fall) and ISC 233, 234 (Spring) replaces PHY 103/104, CHM 201 and COS 126

**All other courses substitutions must be approved *in writing* by the Departmental Representative.**

**Design Courses:**

MAE 321 Engineering Design

MAE 322 Mechanical Design

MAE 332 Aircraft Design

MAE 342 Space System Design

MAE 412 Microprocessors for Measurement and Control

CEE 477 Engineering Design for Sustainable Development (for students participating in the Sustainable Energy Program)

## Mechanical Engineering

Name:		Year:		Advisor:	
-------	--	-------	--	----------	--

**HUMANITIES AND SOCIAL SCIENCE REQUIREMENTS** (total of 7 required in four distinct areas)

Distribution Area	Course #	Sem/Yr	Ck	Course #	Sem/Yr	Ck	Course #	Sem/Yr	Ck
(EC) Epist & Cogn									
(EM) Ethic & Moral									
(SA) Social Analysis									
(HA) Historical Analysis									
(LA) Literature & Arts									
(FL) Foreign Language									
(CD) Culture&Difference									

**ENGINEERING SCHOOL REQUIREMENTS** (total of 8 courses required or AP Credit)

Course	Check	Semester/Yr	Course	Check	Semester/Yr
MAT 103			PHY 103 OR 105*		
MAT 104			PHY 104 OR 106*		
MAT 201 OR 203*			CHM 201 OR 203*		
MAT 202 OR 204*			COS 126*		

**DEPARTMENTAL REQUIREMENTS** (15 courses required)

Course	Check	Semester/Yr	Course	Check	Semester/Yr
<u>MAE 221</u>			<u>MAE 206</u>		
MAE 223			MAE 222		
MAE 305			MAE 224 Lab		

**Upper Level Departmental Requirements:** ( ) = Number of Courses Required

	Course	Semester/Yr	Course	Semester/Yr	Course	Semester/Yr
Materials (1)	MAE 324 or MSE 301					
Design (3) **	MAE 321		MAE 322 or 412 or CEE 477			
Math Elective (1)						
Required Technical Electives (4)	MAE 335 or 336 or 423		CEE 361 or 312 or MAE 323		Tech Elective	
Senior IW -or- Senior Thesis -or- Senior Project	MAE 439 MAE 442 MAE 444		MAE 440		One semester of independent work is required. More than one suggested.	
<b>Mech Requirements:</b>	MAE 321, MAE 322/412, MAE 335/336/423, Math Elective, Tech Elective, MAE 433, Materials, CEE 361(MAE325)/CEE312, Sr. IW or Sr. Thesis or Sr. Project - satisfies 3rd Design Requirement					
<b>Checklist</b>	Course	Semester/Yr	Course	Semester/Yr	Course	Semester/Yr
Free Electives/ Additional Courses (Non-Tech Electives)						
Writing Requirement (1)						
Total # of Courses Must Equal 36			Certificate Programs			

\*See back page for approved alternate courses

\*\*Third design requirement will be satisfied by either Senior Independent Work, Senior Thesis, or Senior Project



OUTSIDE COURSES (If Applicable)			
Princeton Equivalent Course #	Name of University	Semester & Year	Comments

**Notes:**

**Substitutions not requiring Departmental Representative's Approval:**

**Math:**

EGR 192 replaces MAT 201 or MAT 203

**Physics:**

PHY 107/108/109 sequence "General Physics" may replace the PHY103/105 or PHY 105/106 sequence

EGR 191 replaces PHY 103 or PHY 105

EGR 193 replaces PHY 104 or PHY 106

**Chemistry:**

CHM 207 Advanced General Chemistry: Materials Chemistry

**NOTE:** ISC 231, 232 (Fall) and ISC 233, 234 (Spring) replaces PHY 103/104, CHM 201 and COS 126

**Suggested Second Math Course:**

MAE 306 (MAT 392) Mathematics in Engineering II (strongly recommended for those planning graduate work in engineering or applied science)

ORF 245 Fundamentals of Engineering Statistics

ORF 307 Optimization

ORF 309 Probability and Stochastic Systems (MAT 380/ELE 380)

ORF 363 Computing and Optimization for the Physical and Social Sciences (COS 323)

COS 302 Mathematics for Numerical Computing and Machine Learning

COS 340 Reasoning About Computation

MAT 330 Complex Analysis with Applications

MAT 393 Mathematical Programming

PHY 403 Mathematical Methods of Physics

**All other courses substitutions must be approved *in writing* by the Departmental Representative.**

**Design Courses:**

MAE 321 Engineering Design

MAE 322 Mechanical Design

MAE 332 Aircraft Design

MAE 342 Space System Design

MAE 412 Microprocessors for Measurement and Control

CEE 477 Engineering Design for Sustainable Development (pre-approved as Mech Design for those students enrolled in the Sustainable Energy Program)

**Technical Electives:**

CB3 341 Mass, Momentum, and Energy Transport (may replace MAE 423 Heat Transfer)

## Mechanical and Aerospace Engineering Programs

Name:	Year:	Advisor:
-------	-------	----------

**HUMANITIES AND SOCIAL SCIENCE REQUIREMENTS** (total of 7 required in four distinct areas)

Distribution Area	Course #	Sem/Yr	Ck	Course #	Sem/Yr	Ck	Course #	Sem/Yr	Ck
(EC) Epist & Cogn									
(EM) Ethic & Moral									
(SA) Social Analysis									
(HA) Historical Analysis									
(LA) Literature & Arts									
(FL) Foreign Language									
(CD) Culture&Difference									

**ENGINEERING SCHOOL REQUIREMENTS** (total of 8 courses required or AP Credit)

Course	Check	Semester/Yr	Course	Check	Semester/Yr
MAT 103			PHY 103 OR 105*		
MAT 104			PHY 104 OR 106*		
MAT 201 OR 203*			CHM 201 OR 203*		
MAT 202 OR 204*			COS 126*		

**DEPARTMENTAL REQUIREMENTS** (15 courses required)

Course	Check	Semester/Yr	Course	Check	Semester/Yr
<u>MAE 221</u>			<u>MAE 206</u>		
MAE 223			MAE 222		
MAE 305			MAE 224 Lab		

**Upper Level Departmental Requirements:**

( ) = Number of Courses Required

	Course	Semester/Yr	Course	Semester/Yr	Course	Semester/Yr
Materials (1)	MAE 324 (AE/ME)		MSE 301 (AE/ME)			
Design (3)	MAE 321 (AE/ME)		MAE 332/342 (AE)		MAE 322/412 (ME)*	
Math Elective (ME) (1)						
Required Technical	MAE 331/341 (AE)		MAE 335 (AE/ME)		MAE 427/426 (AE)	
Electives (5)	MAE 433 (AE/ME)		CEE361/312orMAE323 (AE/ME)			
Senior IW -or-	MAE 439		MAE 440		One Semester of independent work is required. More than one suggested.	
Senior Thesis -or-	MAE 442					
Senior Project	MAE 444					

**Aero Requirements:** MAE 321, MAE 331/341 or MAE 332/342, MAE 335, MAE 427/426, MAE 433, Materials, **Checklist** CEE361orCEE312orMAE323, Sr. IW or Sr. Thesis or Sr. Project - satisfies 3rd Design Requirement

**Mech Requirements:** MAE 321, MAE 322/412, MAE 335/336/423, Math Elective, TE, MAE 433, Materials **Checklist** CEE361orCEE312orMAE323, Sr. IW or Sr. Thesis or Sr. Project - satisfies 3rd Design Requirement

	Course	Semester/Yr	Course	Semester/Yr	Course	Semester/Yr
Free Electives/						
Additional Courses						
(Non-Tech Electives)						
Writing Requirement (1)						

**Total # of Courses Must Equal 36**

**Certificate Program(s):**

\*See back page for approved alternate courses

Revised for AY 20-21

OUTSIDE COURSES (If Applicable)			
Princeton Equivalent Course #	Name of University	Semester & Year	Comments

**Notes:**

**Substitutions not requiring Departmental Representative's Approval:**

**Math:**

EGR 192 replaces MAT 201 or MAT 203

**Physics:**

PHY 107/108/109 sequence "General Physics" may replace the PHY103/105 or PHY 105/106 sequence

EGR 191 replaces PHY 103 or PHY 105

EGR 193 replaces PHY 104 or PHY 106

**Chemistry:**

CHM 207 Advanced General Chemistry: Materials Chemistry

**NOTE:** ISC 231, 232 (Fall) and ISC 233, 234 (Spring) replaces PHY 103/104, CHM 201 and COS 126

**Suggested Second Math Course:**

MAE 306 (MAT 392) Mathematics in Engineering II (strongly recommended for those planning graduate work in engineering or applied science)

ORF 245 Fundamentals of Engineering Statistics

ORF 307 Optimization

ORF 309 Probability and Stochastic Systems (MAT 380/ELE 380)

ORF 363 Computing and Optimization for the Physical and Social Sciences (COS 323)

COS 302 Mathematics for numerical Modeling and Machine Learning

COS 340 Reasoning About Computation

MAT 330 Complex Analysis with Applications

MAT 393 Mathematical Programming

PHY 403 Mathematical Methods of Physics

**All other courses substitutions must be approved *in writing* by the Departmental Representative.**

**Design Courses:**

MAE 321 Engineering Design

MAE 322 Mechanical Design

MAE 332 Aircraft Design

MAE 342 Space System Design

MAE 412 Microprocessors for Measurement and Control

CEE 477 Engineering Design for Sustainable Development (pre-approved as Mech Design for those students enrolled in the Sustainable Energy Program)

**Notes:**